

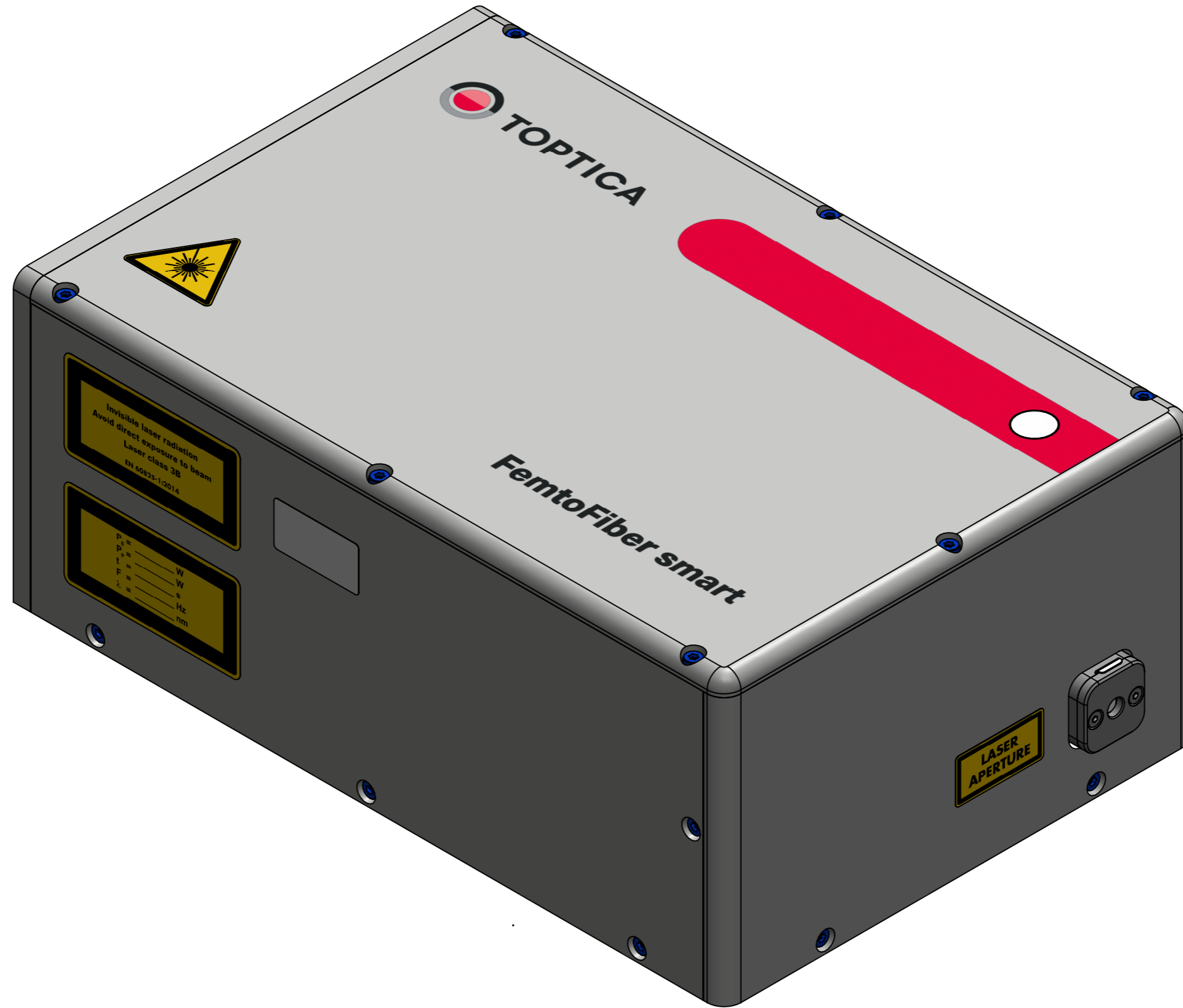



NOTE: This document is property of the company TOPTICA Photonics AG. All copyrights, trademarks, patents and other rights in connection herewith are expressly reserved to the company TOPTICA Photonics AG and no license is created hereby.

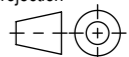
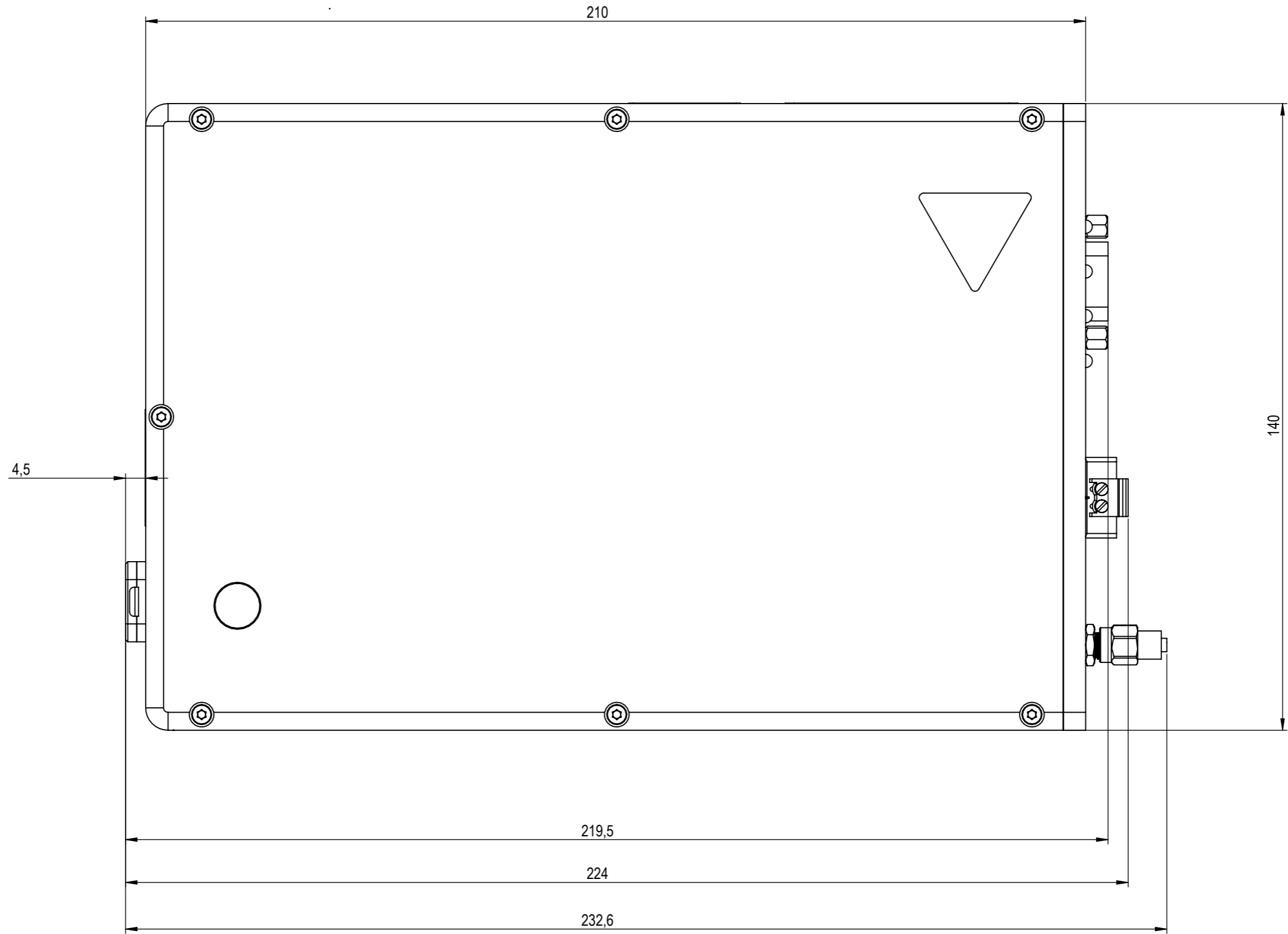

		title		scale
		FemtoFiber smart 780		1:1
<small>TOPTICA Photonics AG Tel.: 089-85837-0 Lochhamer Schlag 19 Fax.: 089-85837-200 82166 Grafelfing Web: www.toptica.com</small>		format		A3
dimensions are in mm	general tolerance	projection	date	sheet
view 3D	DIN ISO 2768 - mK		28.03.24	1/7

NOTE: This document is property of the company TOPTICA Photonics AG. All copyrights, trademarks, patents and other rights in connection herewith are expressly reserved to the company TOPTICA Photonics AG and no license is created hereby.

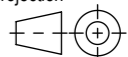

 <small>TOPTICA Photonics AG Tel.: 089-85837-0          Lochhamer Schlag 19 Fax.: 089-85837-200          82166 Grafelfing Web: www.toptica.com</small>	title	scale
	FemtoFiber smart 780	1:1
		format
		A3
dimensions are in mm	general tolerance	projection
view TOP	DIN ISO 2768 - mK	
	date	sheet
	28.03.24	2/7

NOTE: This document is property of the company TOPTICA Photonics AG. All copyrights, trademarks, patents and other rights in connection herewith are expressly reserved to the company TOPTICA Photonics AG and no license is created hereby.

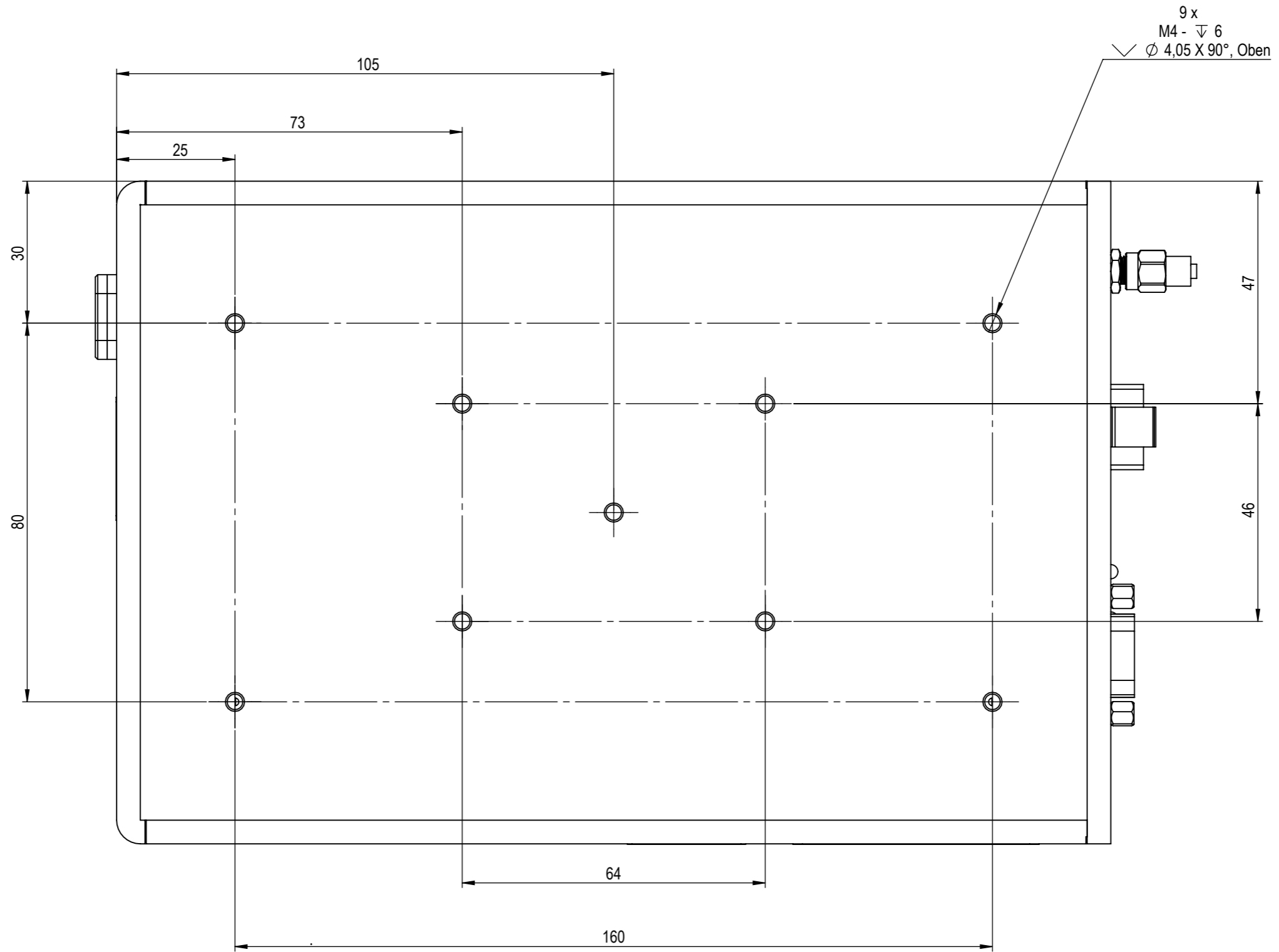

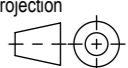
	title		scale
	FemtoFiber smart 780		1:1
<small>TOPTICA Photonics AG Tel.: 089-85837-0 Lochhamer Schlag 19 Fax.: 089-85837-200 82166 Grafelfing Web: www.toptica.com</small>	format		A3
dimensions are in mm view <b>BOTTOM</b>	general tolerance DIN ISO 2768 - mK	projection 	date 28.03.24 sheet 3/7

NOTE: This document is property of the company TOPTICA Photonics AG. All copyrights, trademarks, patents and other rights in connection herewith are expressly reserved to the company TOPTICA Photonics AG and no license is created hereby.

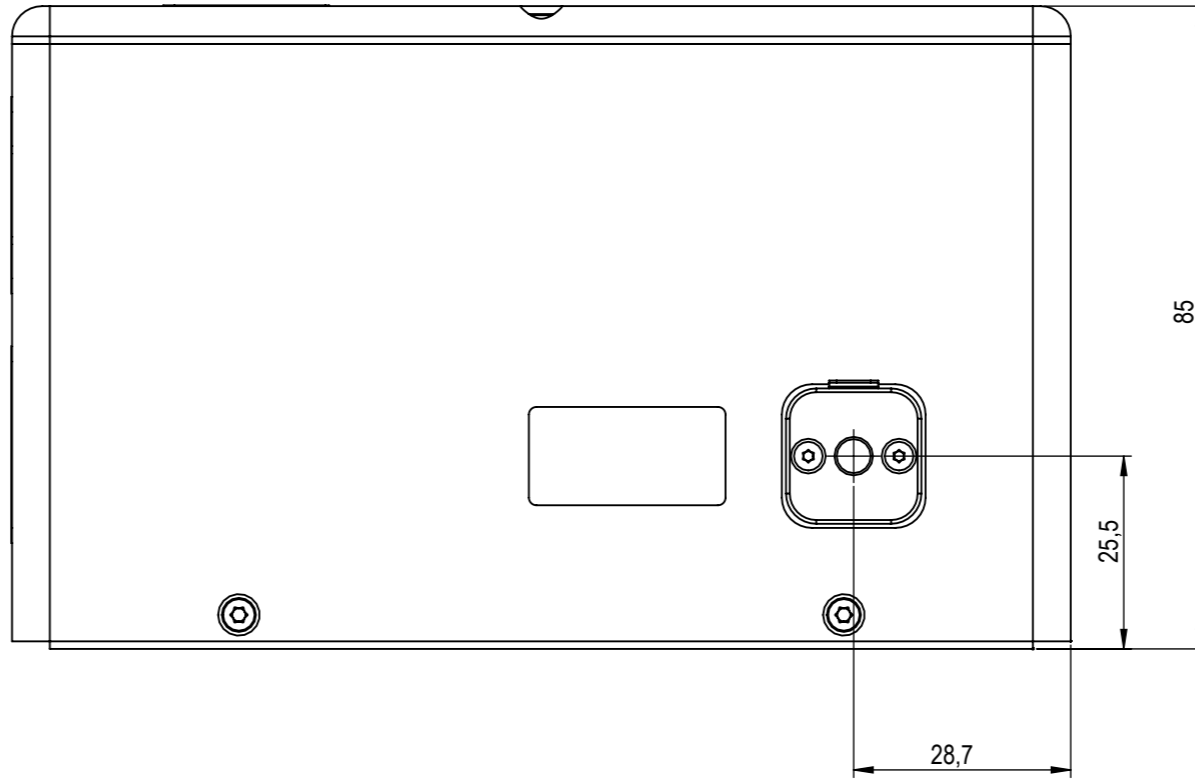

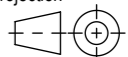
	title		scale
	FemtoFiber smart 780		1:1
<small>TOPTICA Photonics AG Tel.: 089-85837-0 Lochhamer Schlag 19 Fax.: 089-85837-200 82166 Grafelfing Web: www.toptica.com</small>	general tolerance	projection	sheet
dimensions are in mm view FRONT	DIN ISO 2768 - mK		date 28.03.24 4/7

NOTE: This document is property of the company TOPTICA Photonics AG. All copyrights, trademarks, patents and other rights in connection herewith are expressly reserved to the company TOPTICA Photonics AG and no license is created hereby.

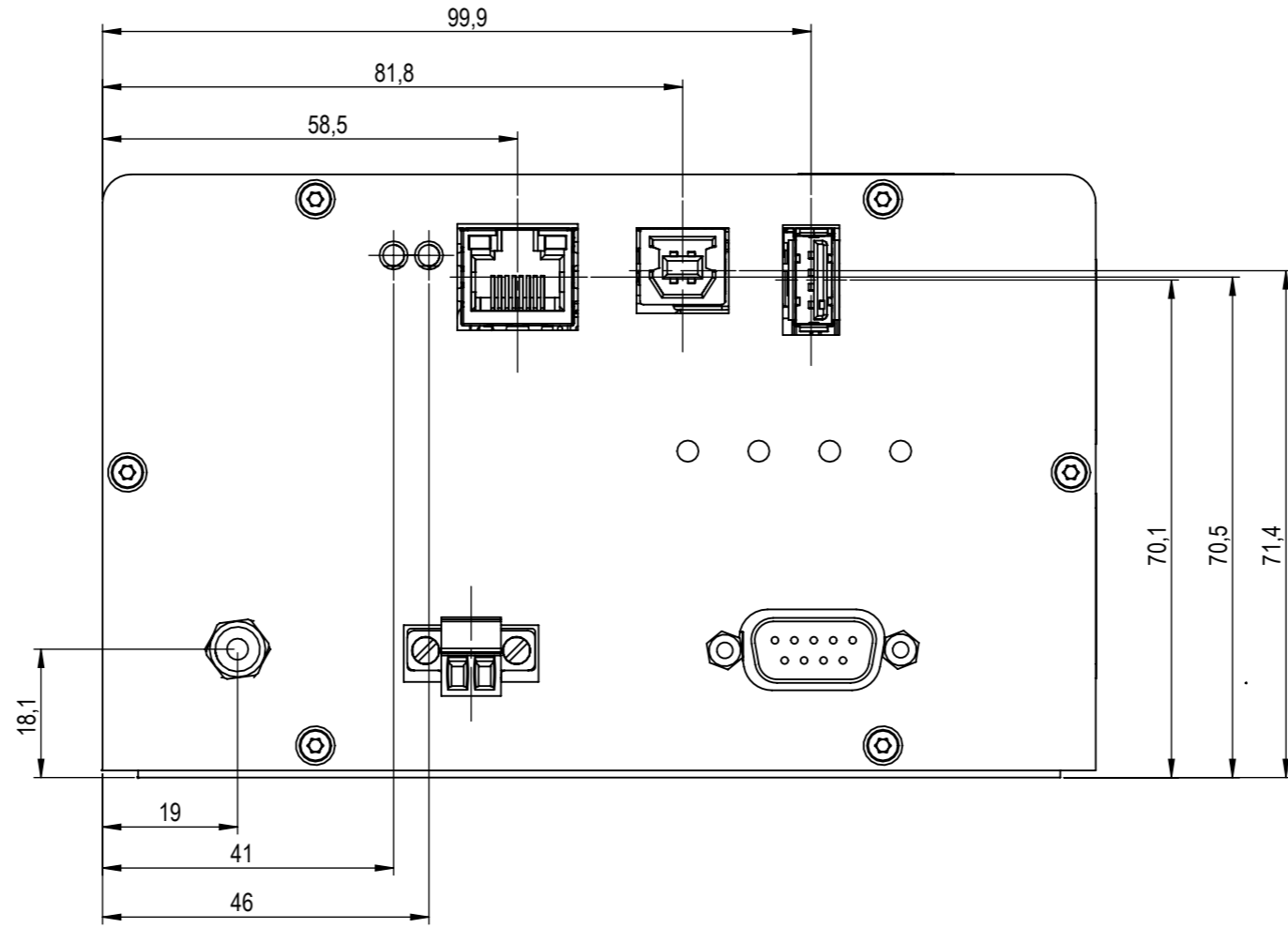

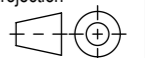
	title		scale
	FemtoFiber smart 780		1:1
<small>TOPTICA Photonics AG Tel.: 089-85837-0 Lochhamer Schlag 19 Fax.: 089-85837-200 82166 Grafelfing Web: www.toptica.com</small>	general tolerance	projection	format
dimensions are in mm view BACK	DIN ISO 2768 - mK		A3
	date	sheet	
	28.03.24	5/7	

NOTE: This document is property of the company TOPTICA Photonics AG. All copyrights, trademarks, patents and other rights in connection herewith are expressly reserved to the company TOPTICA Photonics AG and no license is created hereby.

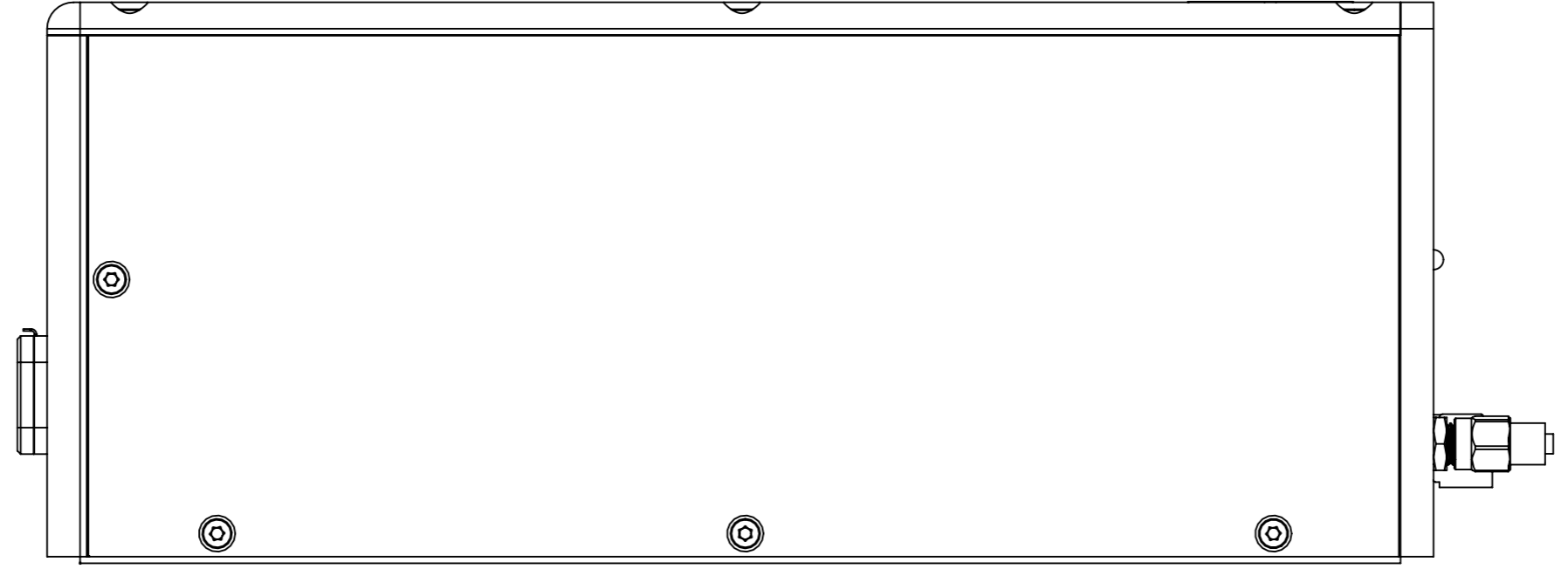

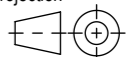
 <small>TOPTICA Photonics AG Tel.: 089-85837-0 Lochhamer Schlag 19 Fax.: 089-85837-200 82166 Grafelfing Web: www.toptica.com</small>	title	scale		
	<b>FemtoFiber smart 780</b>	1:1		
dimensions are in mm	general tolerance	projection	date	sheet
view <b>RIGHT</b>	DIN ISO 2768 - mK		28.03.24	6/7

NOTE: This document is property of the company TOPTICA Photonics AG. All copyrights, trademarks, patents and other rights in connection herewith are expressly reserved to the company TOPTICA Photonics AG and no license is created hereby.

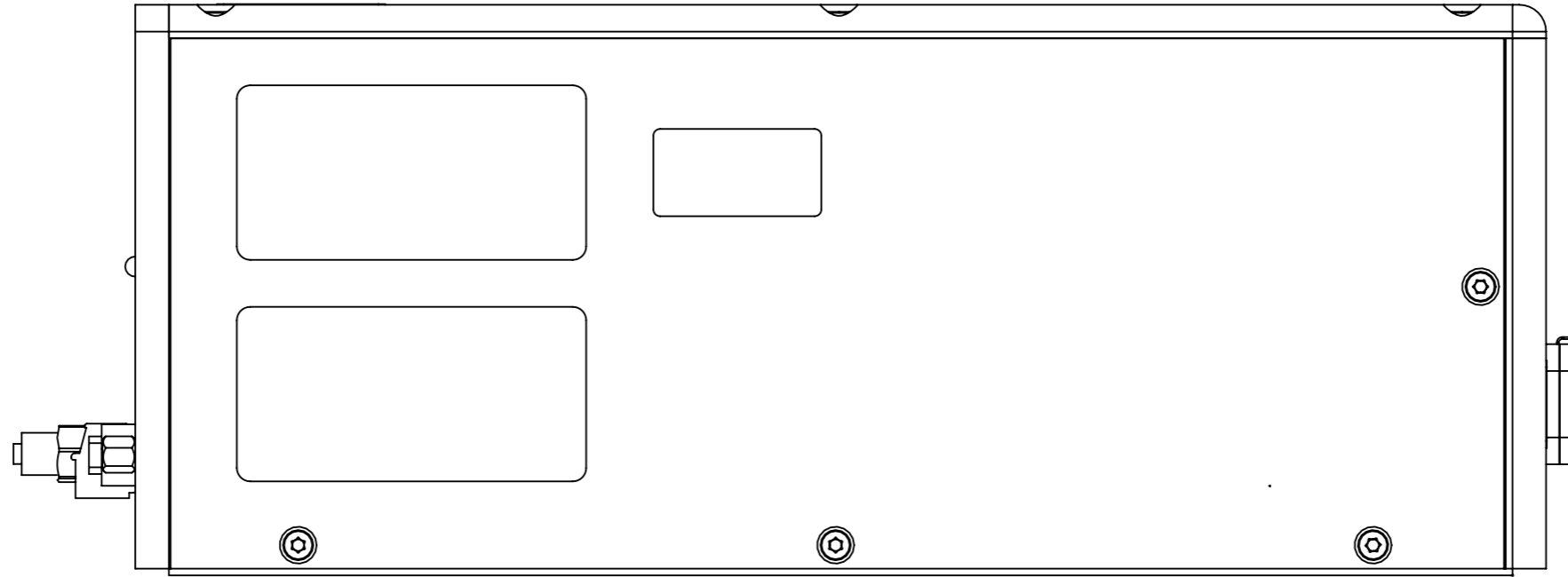

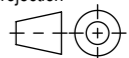
 TOPTICA Photonics AG Tel.: 089-85837-0 Lochhamer Schlag 19 Fax.: 089-85837-200 82166 Grafelfing Web: www.toptica.com	title	scale		
	FemtoFiber smart 780	1:1		
dimensions are in mm	general tolerance	projection	date	sheet
view LEFT	DIN ISO 2768 - mK		28.03.24	7/7